



8812

8818, 8848

8819

8800 SERIES MASTERFLUSH™ MACERATOR TOILETS INSTRUCTION MANUAL

IMPORTANT NOTICE

Dometic® sanitation systems must be installed according to Dometic's recommended procedures.



WARNING

This manual must be read and understood before adjustment, maintenance, or service is performed. Modification of this product can result in property damage.

TABLE OF CONTENTS

MasterFlush Technology Features	2	Proper Cleaning and Maintenance	14
Installation Specifications	2	Extended Periods of Non-use.....	15
Toilet Specifications, Dimensions	3	Winterizing.....	15
Toilet Model Identification	4	Troubleshooting.....	16
Warnings	4	Deodorants and Special Tissue	17
Toilet Start-Up and Operation.....	5	Replacement Parts	18-19
Installation - System Diagrams.....	6-8	Customer Service and Warranty	20
Installation - Toilet Components	9-13		

MASTERFLUSH™ TECHNOLOGY FEATURES

- Virtually silent flushing
- Three automatic flush cycle options:
 - Normal (.82 gal., 3.1 L)
 - Low (.42 gal., 1.6 L)
 - Empty
- Powerful turbine macerator is virtually clog-free; low electrical power draw
- Integral trapway (8818, 8819, 8848) prevents potential odor and noise from entering living space
- Plumbs to pressurized fresh water system (2.5 gpm/9.5 lpm flow rate) or raw water system with remote pump
- Optional shut-down feature prevents overfilling of holding tank

INSTALLATION SPECIFICATIONS

Water Supply	Water valve	Thread size	1/2 inch, 14 TPI
		Flow rate at toilet	2.5 GPM/9.5 LPM
	Raw water pump	Hose ID	1/2 inch/13 mm
		Raw water filters – 2	Coarse, Fine (100)
Discharge Piping	Hose ID	Standard	1.5 inch/38 mm
		with opt. adapter	1 inch/25 mm
	Hose runs	Max. horizontal run	98 ft./30 m
		Max. vertical run	9.8 ft./3 m
Electrical System	Amp draw (avg.)	12 volts DC	10-13 amps
		24 volts DC	5-7 amps
	Circuit breaker	12 volts DC	15 amps* (medium delay)
		24 volts DC	10 amps* (medium delay)

* at 3.28 ft. (1 m) of pump discharge head

TOILET SPECIFICATIONS

Model	Description	Weight
8812	All-ceramic, low-profile macerator toilet with full-size seat and bowl.	38.6 lbs. (17.5 Kg)
8818	All-ceramic, standard height macerator toilet with full-size seat and bowl. Sloped back.	46.3 lbs. (21 Kg)
8819	All-ceramic, standard height macerator toilet with full-size seat and bowl.	56 lbs. (25.4 Kg)
8848	All-ceramic, standard height macerator toilet with full-size seat and bowl. Sloped back. Above-floor discharge.	46.3 lbs. (21 Kg)
Weights may vary \pm 2-3%. Specifications subject to change without notice.		

DIMENSIONS

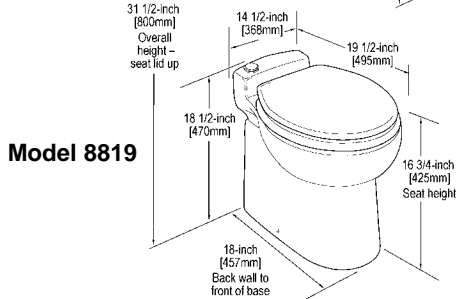
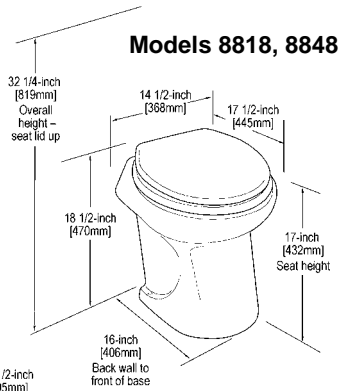
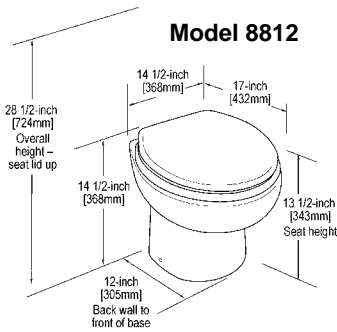

All dimensions may vary \pm 3/8-inch (10mm).

TOILET MODEL IDENTIFICATION

The model identification label is located on the right side of the toilet.

Model: SO 1234	PNC : 123456789
Item: 123456789	
	
Serial: 123456789	
	
Dometic Sanitation www.dometicusa.com	

WARNINGS

The following cautionary statements must be read and understood before installing, servicing and/or operating this product. Modification of this product may result in property damage.

Dometic Sanitation Corporation recommends that a qualified marine technician or electrician install or service this product. Equipment damage, injury to personnel or death could result from improper installation. DOMETIC SANITATION CORPORATION ACCEPTS NO RESPONSIBILITY OR LIABILITY FOR DAMAGE TO EQUIPMENT, OR INJURY OR DEATH TO PERSONNEL THAT MAY RESULT FROM IMPROPER INSTALLATION, SERVICE OR OPERATION OF THIS PRODUCT.

 **WARNING!**
HAZARD OF FLOODING – If the toilet is connected to ANY through-the-hull fittings, properly installed seacocks MUST be installed in all piping connected to through-the-hull fittings. Seacocks MUST be easily accessible to all users of the toilet or secondary valves fitted in hoses where they are easily accessible. All valves MUST be full bore valves and of marine quality. Screw-to-close gate valves are not recommended. Failure to do so can result in flooding which can cause loss of property and life.

 **WARNING!**
HAZARD OF FLOODING – If toilet is connected to ANY through-the-hull fittings, ALWAYS close seacocks when toilet is not in use (even if boat is unattended for a brief period). All passengers MUST be instructed on how to close valves when the toilet is not in use. Failure to do so can result in flooding which can cause loss of property and life.

 **WARNING!**
HAZARD OF FLOODING – If toilet is connected to ANY through-the-hull fittings, ALL flexible hoses must be of marine sanitation quality and must be secured to ANY fittings (such as those at seacock, vented loop or toilet) with two stainless steel, worm-drive hose band clamps at each connection. Connections MUST be checked

frequently for integrity. Failure to comply can result in flooding which can cause loss of property and life.

 **WARNING!**
HAZARD OF FLOODING – If toilet rim is below the waterline at ANY time (during any conditions of heel, load or trim) and is connected to ANY through-the-hull fittings, properly positioned ventilated (vented) loops MUST be installed in intake* or discharge piping to prevent potential back siphonage of seawater into the boat. Failure to do so can result in flooding which can cause loss of property and life.

** if connected to raw water*

 **WARNING!**
HAZARD OF FLOODING – If the toilet uses fresh water for flushing and is connected directly or indirectly to a shoreside municipal water system at ANY time, shoreside water connections MUST be disconnected if the boat is unattended (even if boat is unattended for a brief period). Failure to do so can result in flooding which can cause loss of property and life.

 **WARNING!**
HAZARD OF FLOODING – If toilet uses raw water for flushing at ANY time, a raw water pump controlled by an automatically operating demand switch MUST NOT be installed. If the onboard water valve or any plumbing connections were to leak, the automatically operated pump would start and could flood the boat. Failure to comply can cause loss of property and life.

 **WARNING!**
HAZARD OF FLOODING – Before beginning any work on this product, be sure that all electrical power to the unit has been turned off and that seacocks are in the CLOSED or OFF position. Failure to do so can result in flooding which can cause loss of property and life.

 **WARNING!**
HAZARD OF SHOCK OR FIRE – Always use recommended fuse, circuit breaker and wire size. Failure to do so can result in fire that can cause the loss of property and life.

 **CAUTION:** Overfilling the holding tank can create serious damage to the sanitation system, such as rupturing the holding tank and releasing tank contents into the bilge. To prevent this possibility, Dometic strongly recommends using the “full” tank shut-down relay in the toilet’s electronic control module. The “full” signal from the holding tank can be generated by an optional Tank “Full” Float Assembly, or a TankWatch Level Monitor Kit (see page 19). A “Power/Tank Full” lighted panel is also available (see page 18).

TOILET START-UP

1. Turn on water supply line to toilet.
2. **NORMAL Flush** – Press **NORMAL** button once. After about 9 seconds of water flow, macerator pump will start and run for about 6 seconds to clear bowl. It then takes 4 seconds to refill the bowl.
3. Toss several sheets of toilet paper into bowl and repeat the cycle. The bowl should completely clear.
4. **LOW Flush** – Press **LOW** button. After 3 seconds of water flow, the macerator will complete the discharge within 6 seconds. It then takes 4 seconds to refill the bowl.

TOILET OPERATION

SeaLand macerator toilets are flushed by pressing one of three flush mode buttons:

NORMAL – Flushes solids. Uses only .82 gal. (3.1 L) per flush. Flush cycle lasts 19 seconds.

LOW – For liquid-only flushes. Uses only .42 gal. (1.6 L) per flush. Flush cycle lasts 13 seconds.

EMPTY – Empties water from bowl to avoid splashing during travel.

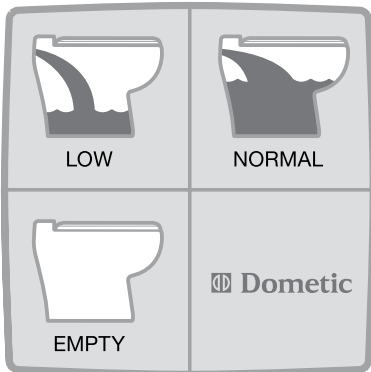

Electronic touchpad

The Dometic touchpad activates a powerful turbine macerator pump in each toilet. The high-speed turbine siphons water and waste from the toilet bowl, through the macerator pump, and into the discharge line/holding tank.

 **CAUTION!**
DO NOT FLUSH FOREIGN OBJECTS – SeaLand toilets are designed to flush only water, bodily wastes and rapid-dissolving toilet tissue. Do not flush wet wipes, sanitary napkins, condoms, diapers, razor blades, paper cups, cotton swabs, food, hair or liquids such as oils or solvents as clogging or damage to the toilet or sanitation system may occur.

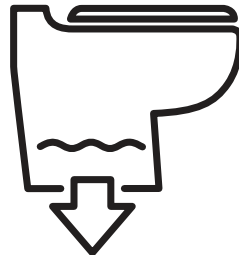

 **CAUTION!**
TURN OFF ELECTRICITY AND WATER TO TOILET IF IDLE FOR LONG PERIODS OF TIME – If people will not be using the boat for a long time (vacations, maintenance, off-season, etc.), or in the event of a long interruption in electricity, electrical power and water supply to the toilet should be shut off. See additional instructions on page 15 regarding “Extended Periods of Non-Use – Laying Up Toilet.”

INSTALLATION - SYSTEM DIAGRAMS

FLUSH WATER OPTIONS

FRESH WATER SYSTEM – All SeaLand macerator toilets can operate with an onboard pressurized freshwater system with a minimum flow rate of 2.5 gpm (9.5 lpm) at the toilet. Onboard freshwater demand systems include a water pump that automatically draws water from a water storage tank when a valve anywhere in the piping system is opened. SeaLand toilets are equipped with

an electrically operated water valve that opens during NORMAL and LOW flushing modes. SeaLand toilets are equipped with an in-line check valve or air gap to prevent contamination of onboard potable supplies. See later sections for specific information on connecting the water line to the toilet.

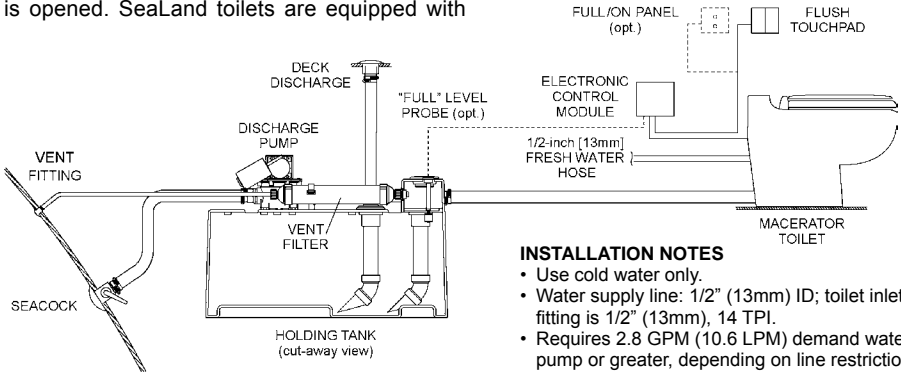

INSTALLATION NOTES

- Use cold water only.
- Water supply line: 1/2" (13mm) ID; toilet inlet fitting is 1/2" (13mm), 14 TPI.
- Requires 2.8 GPM (10.6 LPM) demand water pump or greater, depending on line restrictions.
- Include shut-off valve in water line for maintenance purposes.

RAW WATER SYSTEM – SeaLand macerator toilets can flush on seawater but require a separate pump for this purpose. The pump is activated by the signal from the toilet's electronic control module that would operate the integral water valve in a fresh water system. Since raw water pumps operate at a higher amperage than the freshwater water valve, a 12 or 24 volt DC electrical relay must be inserted into the electrical cables connected to the pump. A kit is available to convert the standard freshwater toilet to raw water. The kit contains the electrical relay, hose insert adapter and related hardware.

Please contact your nearest Dometic Sanitation sales office or distributor for complete details.

WARNING!
HAZARD OF FLOODING – If toilet uses raw water for flushing at ANY time, a raw water pump controlled by an automatically operating demand switch **MUST NOT** be installed. If the onboard water valve or any plumbing connections were to leak, the automatically operated pump would start and could flood the boat. Failure to comply with this warning can cause loss of property and life. See other WARNINGS (p. 4).

INSTALLATION NOTES

- See Notes from Fresh Water System.
- Seacock must be full-flow, marine-quality valve (not screw-to-close type).
- Use primary and secondary raw water filters.
- Raw water pump **MUST NOT** be demand type. Pump is controlled by signal from Control Module near toilet.
- Position vented loop as shown between discharge side of water pump and toilet. Must be equipped with integral check valve that permits air into line to prevent siphoning.

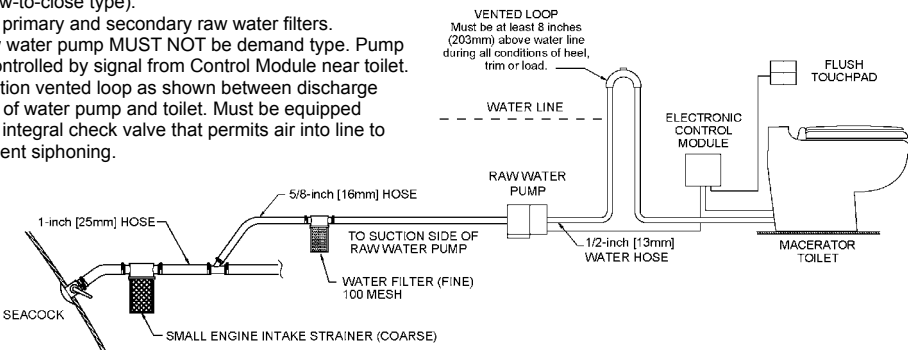

INSTALLATION - SYSTEM DIAGRAMS (cont'd)

DISCHARGE PIPING

SeaLand macerator toilets can be connected to 1-1/2-inch (38mm) ID flexible sanitation hose or adapted to 1-inch (25mm) ID hose with a 1-1/2" x 1" adapter available from a SeaLand product dealer. Connections can be made either through the floor or out the rear of the toilet above the floor.

Flexible hoses that contain sewage from any marine toilet will create unpleasant odor that

permeates through the wall of the hose. Avoid this condition by installing the tank in the lowest position in the boat so that hose contents will drain into the holding tank. Rigid PVC pipe can also be installed in runs that hold trapped sewage. The marine sanitation hose most resistant to odor permeation is OdorSafe Plus® hose, available from your local SeaLand product dealer.

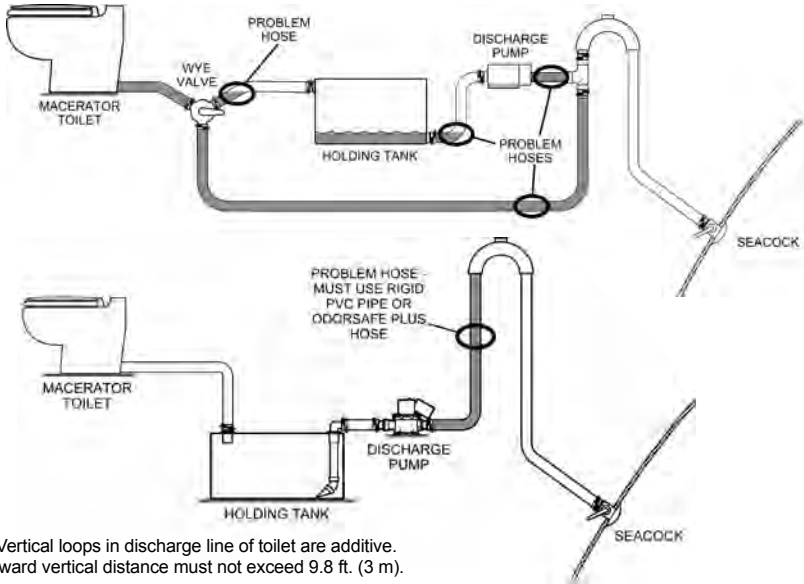

NOTE: Vertical loops in discharge line of toilet are additive. Total upward vertical distance must not exceed 9.8 ft. (3 m).

VENTED LOOPS

Ventilated or vented loops are intended to prevent back siphonage of seawater into the toilet. If the toilet rim is below the waterline at ANY time in ANY conditions of heel, load or trim, a vented loop MUST be installed in the

hose run at a point at least 8-inch (20.3 cm) above the waterline in all such conditions. See vented loop fitting manufacturer's recommendation for further information.

WARNING!
HAZARD OF FLOODING - If toilet rim is below the waterline at ANY time (during any conditions of heel, load or trim) and is connected to ANY through-hull fittings, properly positioned ventilated (vented) loops MUST be installed in intake* or discharge piping to prevent potential back siphonage of seawater into the boat. Failure to do so can result in flooding which can cause loss of property and life.

* if connected to raw water

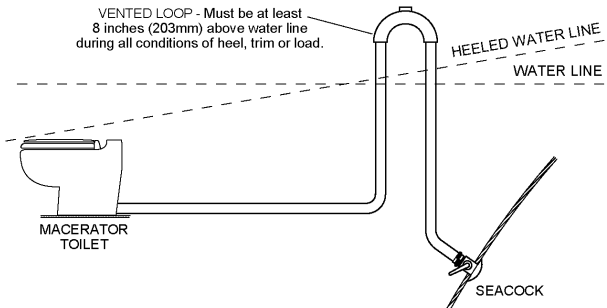

INSTALLATION – SYSTEM DIAGRAMS (cont'd)

HOLDING TANKS

SeaLand macerator toilets operate with most holding tank or treatment systems. If installed with a holding tank, however, the capacity of the tank should be sufficient to avoid the inconvenience of discharging it too frequently. The average flush volume is .96 gallons (3.6 liters) including flushwater and waste. A 30-gallon tank (114-liter) will become full in about 30 flushes.



CAUTION: Overfilling the holding tank can create serious damage to the sanitation system, such as rupturing the holding tank and releasing tank contents into the bilge. To prevent this possibility, Dometic strongly recommends using the “full” tank shut-down relay in the toilet’s electronic control module. The “Full” signal from the holding tank can be generated by any SeaLand TankWatch level monitor system.

SEACOCKS

Seacocks are required by various marine regulations. Only full flow, marine quality valves are recommended. Some regulations require the seacocks be configured so they can be locked in a closed position. Seacocks **MUST** be installed according to the manufacturer’s instructions.



WARNING!
HAZARD OF FLOODING – If the toilet is connected to **ANY** through-the-hull fittings, properly installed seacocks **MUST** be installed in all piping connected to through-the-hull fittings. Seacocks **MUST** be easily accessible to all users of the toilet or secondary valves fitted in hoses where they are easily accessible. All valves **MUST** be full bore valves and of marine quality. Screw-to-close gate valves are not recommended. Failure to do so can result in flooding which can cause loss of property and life.

RISER STEP OR PLINTH INSTALLATIONS (SEAT HEIGHT)

SeaLand macerator toilets are available in three models to accommodate various spaces. While the major factor in selecting a model for a boat is the space provided to fit the toilet into the head compartment, seating height is also important. A comfortable seating height is about 20 inches (508 mm).

Refer to the dimensional drawings on page 3 and the chart below to determine the optimum toilet for a given installation.

Toilet Model	Seating Height
8812	13.5 in. (343 mm)
8818/8848	17 in. (432 mm)
8819	16.75 in. (425 mm)

INSTALLATION - TOILET COMPONENTS

MAJOR TOILET SYSTEM COMPONENTS

Each SeaLand toilet system with Master-Flush technology includes the SeaLand Macerator Toilet with integral turbine pump and solenoid water valve. The Electronic Control Module must be mounted in a easily accessible location such as under the bathroom sink or basin. All electrical connections are made to this module.

The connections from the electronic control module to the toilet and to the flush touchpad include cables with pre-wired connectors. Main power leads are brought to the electronic control module. Connections to remote level monitors and raw water pumps are also made here. In addition, the Flush Control Touchpad must be mounted in a user-friendly location.

Be sure module, wires and connections are installed in dry locations and not susceptible to water contact.

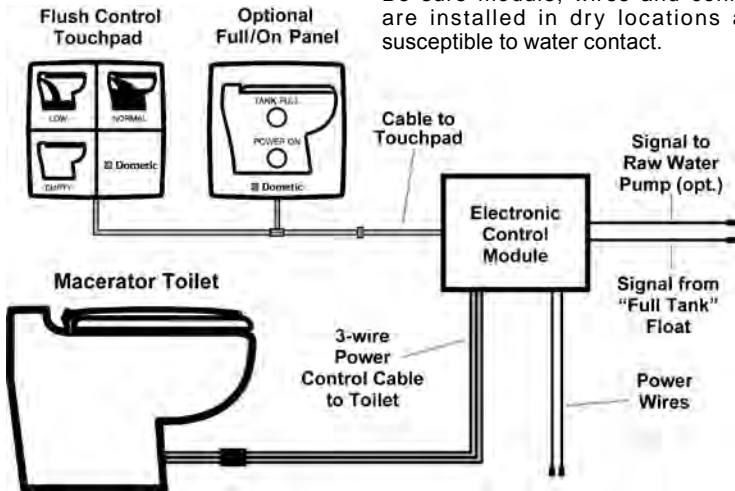

WIRING / ELECTRONIC CONTROL MODULE CONNECTIONS



WARNING! HAZARD OF SHOCK OR FIRE

– Always use recommended fuse, circuit breaker and wire size. Failure to do so can result in fire that can cause the loss of property and life.

IMPORTANT INSTALLATION NOTES

- Each toilet must have its own medium-delay circuit breaker or fuse.
- Wire sizes must be appropriate for the installation. All other installation factors must be in accordance with ABYC/ISO electrical standards.
- Always use stranded copper wire (preferably tinned).
- Always use crimp-type wire connections. Do not use wire nuts (they corrode).

WIRE SIZING CHART

Wire size per length of run*	0-50 ft.	51-100 ft.	100-150 ft.	–
12 volts DC	#12	#10	#8	–
	0-30 ft.	31-100 ft.	101-175 ft.	176-250 ft.
24 volts DC	#14	#12	#10	#8

* In marine applications, wire run equals total distance from circuit breaker to control module and ground.

CONVERSION TABLE

Wire – AWG to mm ²					Feet to Meters								
AWG	14	12	10	8	Ft.	10	15	20	30	50	75	100	150
mm ²	2.5	4.0	6.0	10.0	M	3.0	4.6	6.1	9.2	15.2	22.9	30.5	45.7

INSTALLATION - TOILET COMPONENTS (cont'd)

WIRING SCHEMATIC

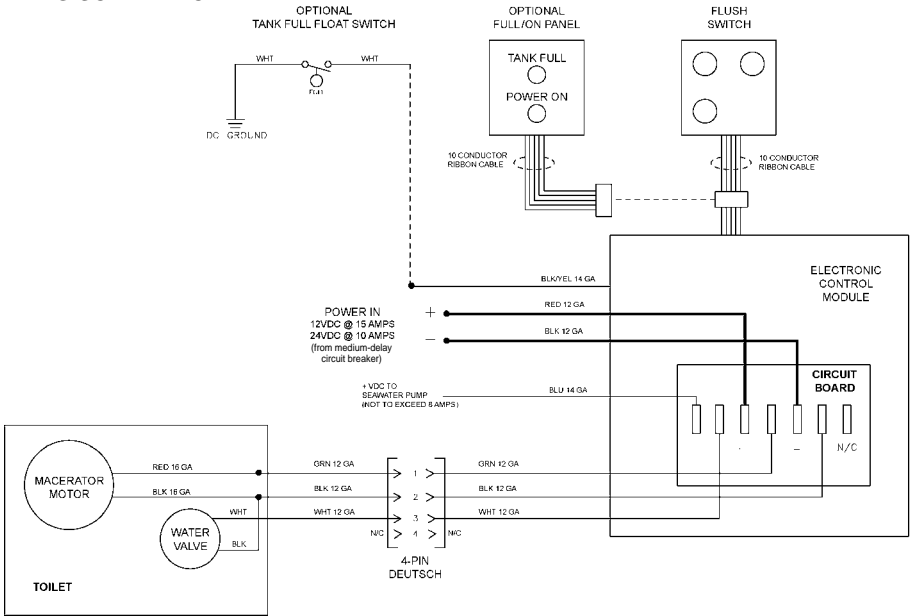

SYSTEM COMPONENTS (included with toilet)



- A. Macerator Toilet
- B. Flush Control Touchpad Kit
- C. Electronic Control Module
- D. Straight Discharge Adapter
- E. Toilet Floor Bracket Kit
- F. Toilet Mounting Template (8812, 8819 only)

INSTALLATION - TOILET COMPONENTS (cont'd)

TOOLS REQUIRED

- Hole saws – 1" (25 mm), 1.25" (32 mm), 2" (51 mm), 2.25" (57 mm) diameters
- Drill bit – 3/16" (4.8 mm)
- Phillips head screwdriver
- 3/8" (10 mm) socket wrench

THROUGH-THE-FLOOR CONNECTIONS

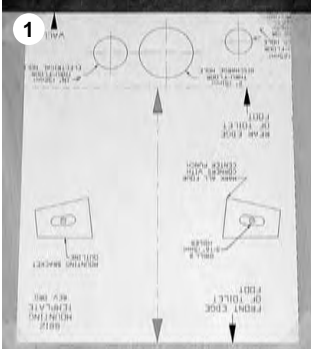

Place template in desired location.



Center-punch holes and mounting bracket corners.



Drill hole centers as shown on template. Do not drill mounting bracket corners.

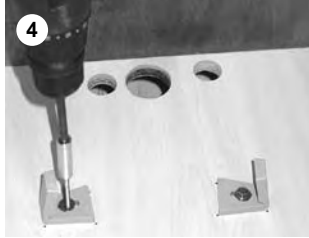

With long hex-head screws from toilet floor bracket kit, fasten floor brackets with 3/8" (10 mm) socket wrench using corner marks as guides.

NOTE: Do not completely tighten hex-head screws to floor – allow brackets to slightly slide. Brackets will tighten when fastening toilet to brackets (see step 14).

Plan locations of touchpad panel and electronic control module and optional accessories so that all electrical connections can be made. Be sure module and wires cannot get wet.



Drill 2.25" (57 mm) hole for touchpad panel.



Fasten touchpad bracket and gasket to wall, making sure mounting tabs are at top and bottom.



Route ribbon cable into wall and snap touchpad panel onto bracket mounting tabs.



Mount electronic control module in cool, dry place.

INSTALLATION - TOILET COMPONENTS (cont'd)



Connect ribbon cables from touchpad panel and control module.



Route power control cable from control module to toilet. Route water supply and discharge plumbing to toilet according to system requirements (see front cover).



Cut discharge hose from toilet to accommodate discharge connection (if necessary).

CAUTION: Do not reduce height of loop in the discharge hose. The loop height prevents water from draining out of bowl, and prevents tank odors from escaping into the interior of the boat or RV.



Place toilet into position, making sure to see the floor brackets through holes at bottom of toilet. Clamp discharge hose from toilet to discharge fitting.



Connect power control cables from control module and toilet.

Complete power connections from circuit breaker to control module using proper electrical wire gauge and components. Complete plumbing system with proper supply and discharge components.

Turn on water supply and electrical power to toilet.

Check for proper toilet operation by pressing the "Normal" flush button to allow water into bowl and through macerator. Repeat flushing cycle as many times as desired to assure proper operation and that no leaks exist in supply and discharge lines and connections.



Insert plastic adapters from Toilet Floor Bracket Kit into holes at bottom of toilet. Fasten toilet to floor brackets with screws.



Cover floor bracket screws with white or chrome covers.

INSTALLATION - TOILET COMPONENTS (cont'd)

THROUGH-THE-WALL CONNECTIONS



To route wiring and plumbing connections through the wall, use floor template to locate vertical centerline of each hole, then put toilet in proper position and mark horizontal centerlines. Drill hole sizes as indicated on template. Route wiring and plumbing through holes, and then install toilet.

8819 WATER LINE CONNECTION OPTIONS



Gray water line has both a 90-degree and straight connector at its ends. Select best connector for your installation, then measure and cut water line.



Connect elbow fitting to water valve for through-the-wall connection.



Connect straight fitting to water valve for through-the-floor connection.

PROPER BOWL CLEANING

For stubborn bowl stains, use SeaLand® Toilet Bowl Cleaner (Fig. A). It's manufactured especially for use with SeaLand macerator toilets. In certain locations where water is hard, a build-up of lime may dull the toilet bowl finish. Restore the shine with this SeaLand cleaner. If you cannot find it in your area, contact Dometic for your nearest dealer. If the SeaLand Toilet Bowl Cleaner is not available, you can also use most non-abrasive bathroom and toilet bowl cleaners (Bar Keeper's Friend® spray cleaner, Clorox® toilet bowl cleaner, SaniFlush® toilet bowl cleaner, etc.). Please follow label instructions.



**To avoid damaging the internal seals,
DO NOT USE:**

- **abrasives (Comet®, Soft Scrub® cleansers etc.)**
- **caustic chemicals (Drano® clog remover, etc.)**
- **lubricants and cleaners containing alcohols or petroleum distillates (Pam® cooking spray, Pine-Sol® cleaner, WD-40® lubricant, etc.).**

® Bar Keepers Friend is a registered trademark of SerVaas Laboratories Inc.

® Clorox, Pine-Sol and Soft Scrub are registered trademarks of The Clorox Co.

® Comet is a registered trademark of Prestige Brands International.

® Drano is a registered trademark of S.C. Johnson & Son Inc.

® Pam is a registered trademark of ConAgra Foods.

® Sani-Flush is a registered trademark of Reckitt Benckiser Inc.

® WD-40 is a registered trademark of WD-40 Company.

ROUTINE TOILET MAINTENANCE

MONTHLY:

1. Inspect toilet, plumbing and plumbing connections, wires and wiring connections.
2. Open and close all valves, including seacocks.
3. Check in-line water filters and vented loops for blockage.

YEARLY:

1. Check internal filter in water valve. Also check filter when water flow into toilet bowl becomes insufficient.

EXTENDED PERIODS OF NON-USE – LAYING UP TOILET

The macerator pump and sanitation hoses should be treated if toilet will not be needed for an extended period of time (more than two weeks and especially in hotter weather).

1. Flush toilet in “Normal” mode and add 4 oz. (118 ml) of liquid biodegradable laundry detergent (should NOT contain bleach or environmentally harmful substances). Note: If using sea water for flushing, shut off power to sea water pump and add fresh water by pouring directly into the bowl during the flush cycle.
2. Flush toilet at least five times.
3. Turn off water supply to toilet.
4. Flush the toilet without water. Repeat three times. (This procedure will minimize any remaining water in the macerator pump.)
5. Turn off power to the toilet (and water supply pump if flushing with sea water).
6. Close all seacocks.

If system will be subjected to freezing temperatures, please follow above procedure, and then winterize system as described below.

WINTERIZING

At the end of each season, the SeaLand macerator toilet should be winterized for storage by using potable water-safe antifreeze (if boat or vehicle will be exposed to freezing temperatures).

NOTE: Use nontoxic antifreeze designated for potable water systems. (See boat or vehicle owner’s manual.)

CAUTION: Never use automotive-type antifreeze in freshwater systems.

PRESSURIZED FRESH WATER SYSTEM

1. Drain potable water tank and empty holding tank.
2. Add freshwater antifreeze to potable water tank.
3. Flush potable water antifreeze and water mixture through toilet(s) and into entire system, including the waste holding tank, diverter valve connections, discharge pumps, etc. Turn off power to toilet.

Each installation is different, so amounts may vary. User discretion is required to assure adequate protection.

RAW WATER SYSTEM

Parts required:

- 1-1/2-inch (38mm) ID hose, about 3-feet (1m) long
- 5/8-inch (16mm) ID hose, about 3-feet (1m) long
- two containers

1. Close intake and discharge seacocks. See Hazard of Flooding risks on page 4.
2. Turn off power to toilet.
3. Disconnect and drain intake hose, discharge hose, and in-line filters.
4. Connect 5/8-inch (16mm) ID hose to raw water pump intake and 1-1/2-inch (38mm) ID hose to toilet discharge.
5. Place one container under hose connected to toilet’s discharge.
6. Place hose connected to intake pump into bucket with antifreeze and pour antifreeze in other container.
7. Turn on power to toilet and flush until antifreeze is removed from toilet.
8. Disconnect power to toilet and reconnect all intake and drain hoses.

TROUBLESHOOTING

Problem	Possible Cause	Service Instructions
1. Flush cycle operates correctly but water in the bowl empties slowly or not at all.	<ul style="list-style-type: none"> a. Discharge piping is pinched or kinked. b. Discharge piping is too high. (Remember, all upward vertical loops and should not exceed a total of 9.8 feet (3 m) in height.) c. The macerator pump or discharge piping is blocked. 	<ul style="list-style-type: none"> a. Check discharge piping. b. Reroute discharge piping. c. Close seacocks and clear blockage.
2. Macerator pump makes unusually loud noise or continually trips breaker.	<ul style="list-style-type: none"> a. Foreign material in pump chamber. 	<ul style="list-style-type: none"> a. Close seacocks and clear foreign material.
3. Flush cycle is not activated after pushing on flush button.	<ul style="list-style-type: none"> a. Holding tank is full and signal from tank has shut down electrical power to toilet. b. Electrical power to toilet is shut off or disrupted. c. Flush Control Touchpad is malfunctioning. d. Circuit board in Electronic Control Module is malfunctioning. 	<ul style="list-style-type: none"> a. Empty holding tank. b. Check wiring and circuit breakers (or fuses). c. Replace touchpad. d. Replace control module.
4. Insufficient or no water enters the bowl.	<ul style="list-style-type: none"> a. Water supply line is pinched or kinked. b. Screen in water valve is blocked. c. Intake water filters are blocked (in raw water system). d. Water valve is malfunctioning. 	<ul style="list-style-type: none"> a. Check water supply line. b. Clear blockage at water valve. c. Clear water filters. d. Replace water valve.
5. Fresh water demand pump turns on and off repeatedly during toilet operation.	<ul style="list-style-type: none"> a. Pump cut-out pressure is too low (25 PSI or less). b. Pump GPM output exceeds water valve input. c. Water valve screen is blocked. d. Water valve is malfunctioning. 	<ul style="list-style-type: none"> a. Install an in-line water accumulator tank or upgrade the water pump. b. Install an in-line water accumulator tank. c. Clear blockage at water valve screen. d. Replace water valve.

DEODORANTS AND SPECIAL TISSUE

Your SeaLand MasterFlush toilet requires the regular addition of a deodorant product to reduce malodors and to help break down holding tank contents. Several factors should be considered in selecting a deodorant product.

Liquid or Granulated. Liquid products work more quickly by readily going into solution. Granulated powder formulations have the advantage of requiring less storage space and are less likely to leak if the package is inadvertently damaged.

Formaldehyde versus Non-Formaldehyde. Dometic manufactures both types of deodorants. Generally speaking, formaldehyde formulas control odor very effectively at all temperatures and with all degrees of water hardness. Both SeaLand® NATURAL Environment-Friendly and Clean 'n Green™ brands, which are formaldehyde-free, are similarly effective.

How Much Deodorant and How to Add It. The deodorant is added directly into the toilet bowl, then flushed into the holding tank. Follow bottle or package instructions. Conditions of extremely warm weather, longer waste holding time and larger tank capacities may require more deodorant treatment. Also, to maintain optimum efficiency in odor control, the waste holding tank should be cleaned thoroughly at least once or more each season depending on use.

Why Not Use Household Toilet Paper in Your Toilet. Household tissues often contain adhesives which bond together the paper fibers from which the tissue is made. The adhesives prevent the tissue from breaking apart, and their use in "ultra-low flow" systems can cause system clogging. SeaLand tissue is especially designed for use in low water toilet systems. Its rapid dissolving properties minimize the amount of residual paper in the holding tank and allow deodorizers to work more efficiently.

SeaLand Brand versus Other Brands. We constantly strive to provide our system owners with effective products that have minimal environmental impact and good value. Many deodorant products do not measure up to our standards of performance and value.



SeaLand® Clean 'n Green
Bowl Cleaner/Tank Deodorant
12-2 oz. drop-in pouches
Part No. 379512602



SeaLand® NATURAL
Liquid Deodorant
32-oz. bottle
Part No. 379114032



SeaLand® Cleaner
16-oz. bottle
Part No. 379314016



SeaLand®
MAX CONTROL
Dry Deodorant
Six 2-oz. pouches
Part No.
379626002









SeaLand®
Rapid-Dissolving
Toilet Tissue
Four 400-sheet rolls
Part No. 379441204

REPLACEMENT PARTS

	Description	Item Number
	Seat assembly - white	385880001
	Seat assembly - bone	385880002
	Macerator Motor Ass'y- 12 VDC	385880009
	Macerator Motor Ass'y - 24 VDC	385880010
	Discharge loop kit – models 8812, 8819	385880062
	Discharge loop kit – model 8818	385880064
	Discharge loop kit – model 8848	385880063
	Bowl-to-macerator adapter – models 8818, 8819, 8848	385880014
	Bowl-to-macerator adapter – model 8812	385880015
	Water line adapter kit	385880016
	Water valve assembly, 12 VDC	385880021
	Water valve assembly, 24 VDC	385880022
	Touchpad control panel	385880048
	Power/Tank Full panel kit, 12/ 24 VDC	385880057
	Elbow discharge adapter (pre-glued)	385880056

REPLACEMENT PARTS (cont'd)

	Description	Item Number
	Elbow fitting/hose adapter kit (not glued)	385320008
	Electronic control module – 12/24 VDC	385880050
	Tank "Full" float assembly, grommet-style	313900101
	Tank "Full" float assembly, MPT	313900100
	TankWatch "Full" level monitor kit for 12 or 24 VDC systems	313000312
	Raw water adaption kit, 12 VDC	385880059
	Raw water adaption kit, 24 VDC	385880060
	Straight discharge adapter	385880039

CUSTOMER SERVICE

There is a strong, worldwide network to assist in servicing and maintaining your sanitation system. For the Authorized Service Center near you, please call from 8:00 a.m. to 5:00 p.m. (ET) Monday through Friday.

You may also contact or have your local dealer contact the Parts Distributor nearest you for quick response to your replacement parts needs. They carry a complete inventory for the SeaLand product line.

Telephone: 1 800-321-9886 U.S.A. and Canada
330-496-3211 International

Fax: 330-496-3097 U.S.A. and Canada
330-496-3220 International

Web site: <http://www.DometicSanitation.com>
<http://www.DometicSanitation.com/locate.asp>

MANUFACTURER'S TWO-YEAR LIMITED WARRANTY

Dometic Sanitation Corporation warrants, to the original purchaser only, that this SeaLand macerator toilet, if used for personal, family or household-like purposes, and if installed according to Dometic's recommended procedures, is free from defects in material and workmanship for a period of two (2) years from the date of purchase.

If this Dometic product is placed in commercial or business use, it will be warranted, to the original purchaser only, to be free of defects in material and workmanship for a period of ninety (90) days from the date of purchase.

Dometic reserves the right to replace or repair any part of this product that proves, upon inspection by Dometic, to be defective in material or workmanship. All labor and transportation costs or charges incidental to warranty service are to be borne by the purchaser-user.

EXCLUSIONS

IN NO EVENT SHALL **DOMETIC** BE LIABLE FOR INCIDENTAL OR CONSEQUENTIAL DAMAGES, FOR DAMAGES RESULTING FROM IMPROPER INSTALLATION, OR FOR DAMAGES CAUSED BY NEGLIGENCE, ABUSE, ALTERATION, FOREIGN OBJECTS DEPOSITED IN THE TOILET, OR USE OF UNAUTHORIZED COMPONENTS. THIS INCLUDES FAILURES WHICH MAY RESULT FROM NOT FOLLOWING THE WINTERIZATION OR CLEANING PROCEDURES AS DESCRIBED IN THIS MANUAL. ALL IMPLIED WARRANTIES, INCLUDING ANY IMPLIED WARRANTY OF MERCHANTABILITY OR FITNESS FOR ANY PARTICULAR PURPOSE, ARE LIMITED TO A PERIOD OF TWO (2) YEARS FROM DATE OF PURCHASE.

IMPLIED WARRANTIES

No person is authorized to change, add to, or create any warranty or obligation other than that set forth herein.

Implied warranties, including those of merchantability and fitness for a particular purpose, are limited to two (2) years from the date of purchase for products used for personal, family or household-like purposes, and ninety (90) days from the date of purchase for products placed in commercial or business use.

OTHER RIGHTS

Some states do not allow limitations on the duration of an implied warranty, and some states do not allow exclusions or limitations regarding incidental or consequential damages; so, the above limitations may not apply to you. This warranty gives you specific legal rights, and you may have other rights which vary from state to state.

To obtain warranty service, first contact your local dealer from whom you purchased this product.

Dometic is a customer-driven, world-leading provider of innovative leisure products for the caravan, motorhome and marine markets. Dometic offers a complete range of air conditioners, refrigerators, awnings, cookers, sanitation systems, lighting, windows, doors and other equipment that makes leisure life more comfortable away from home.

Dometic also provides refrigerators for specific use in hotel rooms, offices and for storage of medical products and wine. Dometic's products are sold in almost 100 countries and are produced mainly in Dometic's own production facilities around the world. Dometic has more than 4,400 employees.



Dometic Sanitation Corporation

13128 State Rt 226, PO Box 38

Big Prairie, OH 44611

SeaLand Product Customer Service: 1-800-321-9886

Email: sealand@dometicusa.com

www.DometicSanitation.com

® Registered; ™ Trademark of Dometic Corporation

© Dometic Corporation



8800 SERIES MASTERFLUSH™ MACERATOR TOILETS

RV INSTALLATION APPENDIX

When installing a SeaLand macerator toilet in a recreation vehicle, please use the following Wiring information. Refer to SeaLand 8800 series owner's manual (600345326), page 10, for complete SeaLand macerator toilet wiring diagram.

WIRING / ELECTRONIC CONTROL MODULE CONNECTIONS

⚠ WARNING! HAZARD OF SHOCK OR FIRE – Always use recommended fuse, circuit breaker and wire size. Failure to do so can result in fire that can cause the loss of property and life.

IMPORTANT INSTALLATION NOTES

- Each toilet must have its own medium-delay circuit breaker or fuse.
- Wire sizes must be appropriate for the installation. All other installation factors must be in accordance with ISO electrical standards.
- Always use stranded copper wire (preferably tinned).
- Always use crimp-type wire connections. Do not use wire nuts (they corrode).

WIRE SIZING CHART

Wire size per length of run*	0-15 ft.	16-30 ft.	31-50 ft.
12 volts DC	#14	#12	#10
* Distance from circuit breaker to electronic control module.			

CONVERSION TABLES

Wire – AWG to mm ²				Feet to Meters					
AWG	14	12	10	Ft	10	15	20	30	50
mm ²	2.5	4.0	6.0	M	3.1	4.6	6.1	9.2	15.2

